



RP





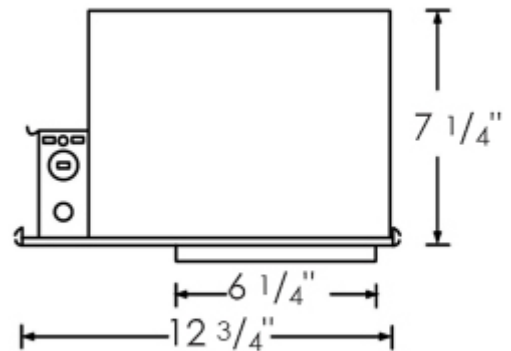
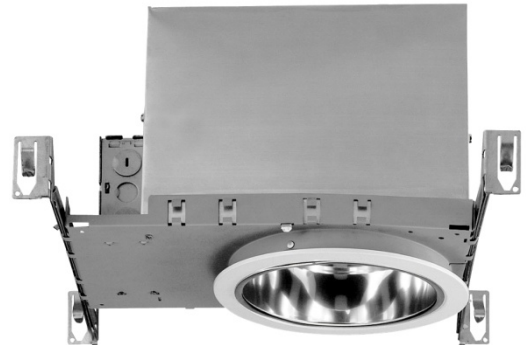

LIGHTING • FANS

Type:
Project:
Comments:
Prepared By:

Part #	8108H
Category #:	8108
EM	EM option 8108H-EM
Description:	6" IC Airtight Compact fluorescent housing
Design Features	
Thermal Protection	Protected against misuse of insulation and improper wiring
IC Rating	IC rated for direct contact with non cellulose insulation
Wall	Double wall construction
J Box	Listed for feed through wiring (4 in-4 out) and seven ½" knockouts & four non metallic cable knockouts w/ strain clamps
Connectors	3-port quick connectors preinstalled in J box
Bar hangers	Pre installed allowing for position at any point w/in a 24" joist span. Can be turned 90° on plaster frame, & to fit T-bar spine w/out additional clamps for use in drop ceilings.
Nails	Pre installed captive nails on bar hangers
Wattage	2x 13W
Lamp	CFL DTT 2 (pin) horizontally mounted
Voltage	120V
Warranty	1 year limited warranty
Listing	
ETL/UL	cULus for damp location
Meets Washington's State energy code for restricted airflow	



Trim Options

	Type	Item#	Finishes	O.D.
	Shower, Lexan, Fresnel Lens	8502FS	Wet location listed Metal trim ring available	8"
	Lexan Flat Opal Albalite Lens	8505AL	Wet location listed Metal trim ring available	8"
	Lexan Drop Opal	8509DR	Wet location listed Metal trim ring available	8"
	Regressed Drop Opal w/White Baffle	8537	Wet location listed White	8"
	Splay	8546	White	8"
	Reflector	8607	Clear and white	8"

Additional Information

1. Adjusts to fit up to 1" ceiling thickness.
2. 7-1/4" height allows use in 2" x 6" joist construction.
3. EM includes pre installed emergency backup which provides 90 minutes of illumination when normal power source fails.